



gebo g316

Complete range of GEBO G316



THREADED FITTINGS

p. 133

- All casted items are made of material 1.4408
- Alloying components in %: C ≤ 0,07 · Cr 18,0 – 20,0 · Ni 9,0 – 12,0 · Mo 2,0 – 2,5
- Bends Code 6003 as well as sockets Code 6270 and 6272 are made from material 1.4404 (AISI 316L)
- Unions with flat seat are equipped with PTFE gaskets
- All items are signed with pressure stages 150 lbs ~ 10,5 bar
- Application areas of materials 1.4408 + 1.4404: water, drinking water, chemical substances, food sector
- High level resistance against acids and corrosion
- Maximum operating temperature (without further mechanical stress): 220°C
- Connection threads according to DIN EN 10226-1 (ISO 7/1)



BALL VALVES

p. 149

- Valves bodies are made from material CF8M, materials of the components are listed in table starting on page 135
- All Valves are equipped with PTFE gaskets
- All Valves are signed with the allowed pressure stages 1000 lbs – 69 bar
- Temperature pressure relation can be taken out from diagrams starting on page 135
- Application area: water and different chemical substances
- Very good resistance against corrosion and acids
- All Valves are equipped with locking device
- Threads according to DIN EN 10226-1 (ISO 7/1)



THREADED PIPE NIPPLES

p. 154

- All threaded pipe nipples and welding nipples are made from welded pipes (material 1.4404) according to DIN EN 10255 (dimensions) and DIN EN 10241 (length)
- Suitable for media: water, drinking water, different chemical substances
- Maximum pressure stage: 50 bar (20°C)
- Threads according to DIN EN 10226-1 (ISO 7/1)

3		BEND 90°, M/M				MAT. 1.4404	
Size [1x2]	Code	Dimensions [mm]					
		L					
1/4"	6003-014	60.0					
3/8"	6003-038	70.0					
1/2"	6003-012	80.0					
3/4"	6003-034	100.0					
1"	6003-100	120.0					
1 1/4"	6003-114	140.0					
1 1/2"	6003-112	160.0					
2"	6003-200	190.0					

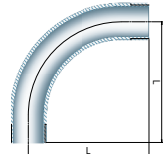

90		ELBOWS 90°, F/F				MAT. 1.4408	
Size [1x2]	Code	Dimensions [mm]					
		L	D1				
1/8"	6090-018	17.0	13.0				
1/4"	6090-014	19.0	16.0				
3/8"	6090-038	23.0	20.0				
1/2"	6090-012	27.0	24.5				
3/4"	6090-034	32.0	30.0				
1"	6090-100	38.0	37.5				
1 1/4"	6090-114	45.0	46.5				
1 1/2"	6090-112	48.0	53.0				
2"	6090-200	57.0	65.5				
2 1/2"	6090-212	69.0	82.0				
3"	6090-300	78.0	95.5				
4"	6090-400	96.0	121.5				

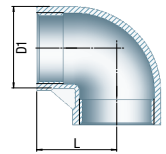

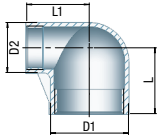

90	REDUCING ELBOWS 90°, F/F	MAT. 1.4408				
Size [1 x 2]	Code	Dimensions [mm]				
		L	L1	D1	D2	
1/2" x 3/8"	6090-012038	25.0	26.0	24.5	20.0	
3/4" x 3/8"	6090-034038	28.0	28.0	30.0	20.0	
3/4" x 1/2"	6090-034012	30.0	29.0	30.0	24.5	
1" x 1/2"	6090-100012	33.0	32.0	37.5	24.5	
1" x 3/4"	6090-100034	35.0	34.0	37.5	30.0	
1 1/4" x 3/4"	6090-114034	40.0	38.0	46.5	30.0	
1 1/4" x 1"	6090-114100	42.0	40.0	46.5	37.5	
1 1/2" x 1"	6090-112100	45.0	41.0	53.0	37.5	
1 1/2" x 1 1/4"	6090-112114	48.0	45.0	53.0	46.5	
2" x 1 1/4"	6090-200114	54.0	48.0	65.5	46.5	
2" x 1 1/2"	6090-200112	55.0	52.0	65.5	53.0	

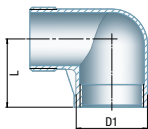

92	STREET ELBOWS 90°, M/F	MAT. 1.4408				
Size [1 x 2]	Code	Dimensions [mm]				
		L	D1			
1/8"	6092-018	17.0	13.0			
1/4"	6092-014	19.0	16.0			
3/8"	6092-038	23.0	20.0			
1/2"	6092-012	27.0	24.5			
3/4"	6092-034	32.0	30.0			
1"	6092-100	38.0	37.5			
1 1/4"	6092-114	45.0	46.5			
1 1/2"	6092-112	48.0	53.0			
2"	6092-200	57.0	65.5			
2 1/2"	6092-212	69.0	82.0			
3"	6092-300	78.0	95.5			
4"	6092-400	97.0	121.5			

95	UNION ELBOWS, FLAT SEAT, F/F	MAT. 1.4408				
Size [1x2]	Code	Dimensions [mm]				
		L	L1	D1	H	
1/4"	6095-014	46.5	13.5	16.0	17.0	
3/8"	6095-038	51.0	15.0	19.0	20.0	
1/2"	6095-012	56.0	16.0	26.0	27.0	
3/4"	6095-034	61.0	17.0	31.5	31.0	
1"	6095-100	70.5	20.0	39.0	36.0	
1 1/4"	6095-114	78.0	22.0	47.5	42.0	
1 1/2"	6095-112	83.0	24.0	54.0	46.0	
2"	6095-200	96.0	27.0	66.5	56.0	

96	UNION ELBOWS, CONICAL SEAT, F/F	MAT. 1.4408				
Size [1x2]	Code	Dimensions [mm]				
		L	L1	D1	H	
1/4"	6096-014	46.5	13.5	16.0	17.0	
3/8"	6096-038	51.0	15.0	19.0	20.0	
1/2"	6096-012	56.0	16.0	26.0	27.0	
3/4"	6096-034	61.0	17.0	31.5	31.0	
1"	6096-100	70.5	20.0	39.0	36.0	
1 1/4"	6096-114	78.0	22.0	47.5	42.0	
1 1/2"	6096-112	83.0	24.0	54.0	46.0	
2"	6096-200	96.0	27.0	66.5	56.0	

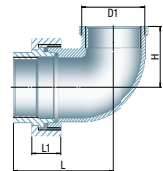
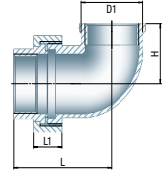

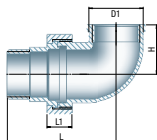

97	UNION ELBOWS, FLAT SEAT, M/F				MAT. 1.4408	
Size [1 x 2]	Code	Dimensions [mm]				
		L	L1	D1	H	
1/4"	6097-014	57.0	13.5	16.0	17.0	
3/8"	6097-038	62.0	15.0	19.0	20.0	
1/2"	6097-012	70.5	16.0	26.0	27.0	
3/4"	6097-034	76.5	17.0	31.5	31.0	
1"	6097-100	88.5	20.0	39.0	36.0	
1 1/4"	6097-114	100.0	22.0	47.5	42.0	
1 1/2"	6097-112	103.5	24.0	54.0	46.0	
2"	6097-200	121.0	27.0	66.5	56.0	

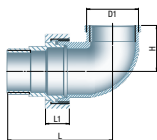

98	UNION ELBOWS, CONICAL SEAT, M/F				MAT. 1.4408	
Size [1 x 2]	Code	Dimensions [mm]				
		L	L1	D1	H	
1/4"	6098-014	57.0	13.5	16.0	17.0	
3/8"	6098-038	62.0	15.0	19.0	20.0	
1/2"	6098-012	70.5	16.0	26.0	27.0	
3/4"	6098-034	76.5	17.0	31.5	31.0	
1"	6098-100	88.5	20.0	39.0	36.0	
1 1/4"	6098-114	100.0	22.0	47.5	42.0	
1 1/2"	6098-112	103.5	24.0	54.0	46.0	
2"	6098-200	121.0	27.0	66.5	56.0	

120		ELBOWS 45°, F/F				MAT. 1.4408	
Size [1x2]	Code	Dimensions [mm]					
		L	D1				
1/8"	6120-018	16.0	13.0				
1/4"	6120-014	17.0	16.0				
3/8"	6120-038	19.0	20.0				
1/2"	6120-012	21.0	24.5				
3/4"	6120-034	25.0	30.0				
1"	6120-100	29.0	37.5				
1 1/4"	6120-114	33.0	46.5				
1 1/2"	6120-112	37.0	53.0				
2"	6120-200	42.0	65.5				

121		STREET ELBOWS 45°, M/F				MAT. 1.4408	
Size [1x2]	Code	Dimensions [mm]					
		L	D1				
1/4"	6121-014	19.0	16.0				
3/8"	6121-038	23.0	20.0				
1/2"	6121-012	27.0	24.5				
3/4"	6121-034	32.0	30.0				
1"	6121-100	38.0	37.5				
1 1/4"	6121-114	45.0	46.5				
1 1/2"	6121-112	48.0	53.0				
2"	6121-200	57.0	65.5				

130		TEES 90°, F/F/F				MAT. 1.4408	
Size [1x2]	Code	Dimensions [mm]					
		L	D1				
1/8"	6130-018	17.0	13.0				
1/4"	6130-014	19.0	16.5				
3/8"	6130-038	23.0	20.0				
1/2"	6130-012	27.0	24.5				
3/4"	6130-034	32.0	30.0				
1"	6130-100	38.0	37.5				
1 1/4"	6130-114	45.0	46.5				
1 1/2"	6130-112	48.0	53.0				
2"	6130-200	57.0	65.5				
2 1/2"	6130-212	69.0	82.0				
3"	6130-300	78.0	95.5				

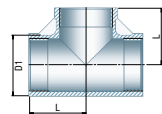
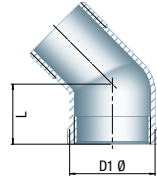
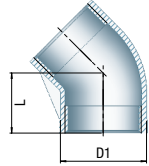

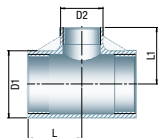

130	REDUCING TEES 90°, F/F/F	MAT. 1.4408				
Size [1 x 2]	Code	Dimensions [mm]				
		L	L1	D1	D2	
1/4" x 1/8"	6130-014018	18.0	18.0	16.0	13.0	
3/8" x 1/4"	6130-038014	20.0	22.0	20.0	16.0	
1/2" x 1/4"	6130-012014	24.0	24.0	24.5	16.0	
1/2" x 3/8"	6130-012038	26.0	25.0	24.5	20.0	
3/4" x 3/8"	6130-034038	28.0	28.0	30.0	20.0	
3/4" x 1/2"	6130-034012	29.0	30.0	30.0	24.5	
1" x 1/2"	6130-100012	32.0	33.0	37.5	24.5	
1" x 3/4"	6130-100034	34.0	35.0	37.5	30.0	
1 1/4" x 3/4"	6130-114034	38.0	40.0	46.5	30.0	
1 1/4" x 1"	6130-114100	40.0	42.0	46.5	37.5	
1 1/2" x 3/4"	6130-112034	37.0	43.0	53.0	30.0	
1 1/2" x 1"	6130-112100	41.0	45.0	53.0	37.5	
1 1/2" x 1 1/4"	6130-112114	45.0	48.0	53.0	46.5	
2" x 1"	6130-200100	44.0	51.0	65.5	37.5	
2" x 1 1/4"	6130-200114	48.0	54.0	65.5	46.5	
2" x 1 1/2"	6130-200112	52.0	55.0	65.5	53.0	

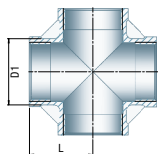

180	CROSSES, F/F/F/F	MAT. 1.4408				
Size [1 x 2]	Code	Dimensions [mm]				
		L	D1			
1/8"	6180-018	17.0	13.0			
1/4"	6180-014	19.0	16.0			
3/8"	6180-038	23.0	20.0			
1/2"	6180-012	27.0	24.5			
3/4"	6180-034	32.0	30.0			
1"	6180-100	38.0	37.5			
1 1/4"	6180-114	45.0	46.5			
1 1/2"	6180-112	48.0	53.0			
2"	6180-200	57.0	65.5			

220	Y-TYPE TEE, F/F/F		MAT. 1.4408			
Size [1x2]	Code	Dimensions [mm]				
		L	D1			
1/4"	6220-014	19.0	16.0			
3/8"	6220-038	23.0	20.0			
1/2"	6220-012	27.0	24.5			
3/4"	6220-034	32.0	30.0			
1"	6220-100	38.0	37.5			
1 1/4"	6220-114	45.0	46.5			
1 1/2"	6220-112	48.0	53.0			
2"	6220-200	57.0	65.5			

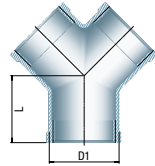

240	REDUCING SOCKETS, F/F		MAT. 1.4408			
Size [1x2]	Code	Dimensions [mm]				
		L	D1	D2		
1/4" x 1/8"	6240-014018	25.0	16.5	13.0		
3/8" x 1/8"	6240-038018	23.0	20.0	13.0		
3/8" x 1/4"	6240-038014	26.0	20.0	16.5		
1/2" x 1/8"	6240-012018	34.0	25.5	13.0		
1/2" x 1/4"	6240-012014	34.0	25.5	16.5		
1/2" x 3/8"	6240-012038	34.0	25.5	20.0		
3/4" x 1/8"	6240-034018	36.0	31.0	13.0		
3/4" x 1/4"	6240-034014	36.0	31.0	16.5		
3/4" x 3/8"	6240-034038	36.0	31.0	20.0		
3/4" x 1/2"	6240-034012	36.0	31.0	24.7		
1" x 3/8"	6240-100038	42.0	38.0	20.0		
1" x 1/2"	6240-100012	42.0	38.0	24.7		
1" x 3/4"	6240-100034	42.0	38.0	31.0		
1 1/4" x 1/2"	6240-114012	48.0	47.0	24.5		
1 1/4" x 3/4"	6240-114034	48.0	47.0	31.0		
1 1/4" x 1"	6240-114100	48.0	47.0	38.0		
1 1/2" x 1/2"	6240-112012	52.0	53.0	24.7		
1 1/2" x 3/4"	6240-112034	52.0	53.0	30.0		
1 1/2" x 1"	6240-112100	52.0	54.0	38.0		
1 1/2" x 1 1/4"	6240-112114	52.0	54.0	47.0		
2" x 1/2"	6240-200012	58.0	66.0	24.7		
2" x 3/4"	6240-200034	58.0	66.0	30.0		
2" x 1"	6240-200100	58.0	66.0	38.0		
2" x 1 1/4"	6240-200114	58.0	66.0	47.0		
2" x 1 1/2"	6240-200112	58.0	66.0	54.0		
2 1/2" x 1 1/2"	6240-212112	65.0	82.0	54.0		
2 1/2" x 2"	6240-212200	65.0	82.0	66.0		
3" x 2"	6240-300200	72.0	96.5	66.0		
3" x 2 1/2"	6240-300212	72.0	96.5	82.0		
4" x 2"	6240-400200	94.0	123.5	66.0		
4" x 2 1/2"	6240-400212	94.0	123.5	82.0		
4" x 3"	6240-400300	94.0	123.5	96.5		

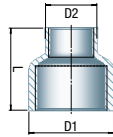



241	HEXAGON BUSHINGS, M/F	MAT. 1.4408			
Size [1 x 2]	Code	Dimensions [mm]			
		L	SW		
1/4" x 1/8"	6241-014018	16.0	14.0		
3/8" x 1/8"	6241-038018	16.5	18.0		
3/8" x 1/4"	6241-038014	16.5	18.0		
1/2" x 1/8"	6241-012018	20.0	22.0		
1/2" x 1/4"	6241-012014	20.0	22.0		
1/2" x 3/8"	6241-012038	20.0	22.0		
3/4" x 1/8"	6241-034018	21.0	27.5		
3/4" x 1/4"	6241-034014	21.0	27.5		
3/4" x 3/8"	6241-034038	21.0	27.5		
3/4" x 1/2"	6241-034012	21.0	27.5		
1" x 1/4"	6241-100014	24.5	34.5		
1" x 3/8"	6241-100038	24.5	34.5		
1" x 1/2"	6241-100012	24.0	34.5		
1" x 3/4"	6241-100034	24.0	34.5		
1 1/4" x 3/8"	6241-114038	27.5	43.0		
1 1/4" x 1/2"	6241-114012	27.5	43.0		
1 1/4" x 3/4"	6241-114034	27.0	43.0		
1 1/4" x 1"	6241-114100	27.0	43.0		
1 1/2" x 3/8"	6241-112038	28.5	49.0		
1 1/2" x 1/2"	6241-112012	28.5	49.0		
1 1/2" x 3/4"	6241-112034	28.5	49.0		
1 1/2" x 1"	6241-112100	28.5	49.0		
1 1/2" x 1 1/4"	6241-112114	28.5	49.0		
2" x 1/2"	6241-200012	33.0	61.0		
2" x 3/4"	6241-200034	33.0	61.0		
2" x 1"	6241-200100	33.0	61.0		
2" x 1 1/4"	6241-200114	32.0	61.0		
2" x 1 1/2"	6241-200112	32.0	61.0		
2 1/2" x 1"	6241-212100	37.0	76.0		
2 1/2" x 1 1/4"	6241-212114	37.0	76.0		
2 1/2" x 1 1/2"	6241-212112	37.0	76.0		
2 1/2" x 2"	6241-212200	37.0	76.0		
3" x 1 1/4"	6241-300114	40.0	90.0		
3" x 1 1/2"	6241-300112	40.0	90.0		
3" x 2"	6241-300200	40.0	90.0		
3" x 2 1/2"	6241-300212	40.0	90.0		
4" x 2"	6241-400200	46.0	115.0		
4" x 2 1/2"	6241-400212	45.0	115.0		
4" x 3"	6241-400300	45.0	115.0		

245		HEXAGON REDUCING NIPPLES, M/M			MAT. 1.4408		
Size [1x2]	Code	Dimensions [mm]					
		d1	d2	SW			
1/4" x 1/8"	6245-014018	8.0	5.5	15.0			
3/8" x 1/8"	6245-038018	11.5	5.5	18.0			
3/8" x 1/4"	6245-038014	11.5	8.0	18.0			
1/2" x 1/8"	6245-012018	15.0	5.5	22.0			
1/2" x 1/4"	6245-012014	15.0	8.0	22.0			
1/2" x 3/8"	6245-012038	15.0	11.5	22.0			
3/4" x 1/4"	6245-034014	20.5	8.0	28.0			
3/4" x 3/8"	6245-034038	20.5	11.5	28.0			
3/4" x 1/2"	6245-034012	20.5	15.0	28.0			
1" x 1/4"	6245-100014	26.0	8.0	35.0			
1" x 3/8"	6245-100038	26.0	11.5	35.0			
1" x 1/2"	6245-100012	26.0	15.0	35.0			
1" x 3/4"	6245-100034	26.0	20.5	35.0			
1 1/4" x 1/2"	6245-114012	34.5	15.0	43.5			
1 1/4" x 3/4"	6245-114034	34.5	20.5	43.5			
1 1/4" x 1"	6245-114100	34.5	26.0	43.5			
1 1/2" x 1/2"	6245-112012	40.0	15.0	49.5			
1 1/2" x 3/4"	6245-112034	40.0	20.5	49.5			
1 1/2" x 1"	6245-112100	40.0	26.0	49.5			
1 1/2" x 1 1/4"	6245-112114	40.0	34.5	49.5			
2" x 1/2"	6245-200012	51.0	15.0	62.0			
2" x 3/4"	6245-200034	51.0	20.5	62.0			
2" x 1"	6245-200100	51.0	26.0	62.0			
2" x 1 1/4"	6245-200114	51.0	34.5	62.0			
2" x 1 1/2"	6245-200112	51.0	40.0	62.0			
2 1/2" x 1 1/2"	6245-212112	65.5	40.0	77.5			
2 1/2" x 2"	6245-212200	65.5	51.0	77.5			
3" x 1 1/2"	6245-300112	77.5	40.0	77.5			
3" x 2"	6245-300200	77.5	51.0	90.5			
3" x 2 1/2"	6245-300212	77.5	65.5	90.5			
4" x 2"	6245-400200	101.5	51.0	90.5			
4" x 2 1/2"	6245-400212	101.5	65.5	116.0			
4" x 3"	6245-400300	101.5	77.5	116.0			

270		SOCKETS, F/F, FULL LENGTH (PIPE MADE)			MAT. 1.4404		
Size [1x2]	Code	Dimensions [mm]					
		L	D1				
1/8"	6270-018	17.0	13.0				
1/4"	6270-014	24.0	16.5				
3/8"	6270-038	25.0	20.0				
1/2"	6270-012	32.0	24.5				
3/4"	6270-034	35.0	30.0				
1"	6270-100	41.0	37.5				
1 1/4"	6270-114	45.0	46.5				
1 1/2"	6270-112	45.0	53.0				
2"	6270-200	54.0	65.5				
2 1/2"	6270-212	63.0	82.0				
3"	6270-300	69.0	95.5				
4"	6270-400	81.0	121.5				

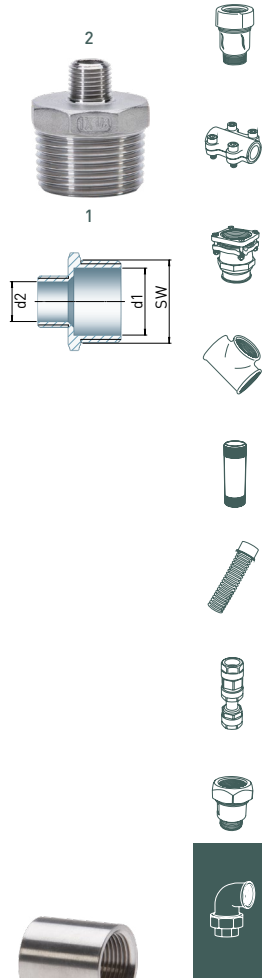

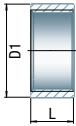

272		SOCKETS, F/F, HALF LENGTH (PIPE MADE)				MAT. 1.4404	
Size [1 x 2]	Code	Dimensions [mm]					
		L	D1				
1/8"	6272-018	7.5	13.0				
1/4"	6272-014	11.0	16.5				
3/8"	6272-038	11.5	20.0				
1/2"	6272-012	15.0	24.5				
3/4"	6272-034	16.5	30.0				
1"	6272-100	19.5	37.5				
1 1/4"	6272-114	21.5	46.5				
1 1/2"	6272-112	21.5	53.0				
2"	6272-200	26.0	65.5				
2 1/2"	6272-212	30.5	82.0				
3"	6272-300	33.5	95.5				
4"	6272-400	39.5	121.5				

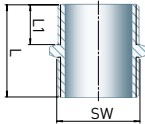

280		HEXAGON NIPPLES, M/M			MAT. 1.4408		
Size [1 x 2]	Code	Dimensions [mm]					
		L	L1	SW			
1/8"	6280-018	20.0	8.0	11.0			
1/4"	6280-014	25.0	10.5	15.0			
3/8"	6280-038	27.0	11.0	18.0			
1/2"	6280-012	34.0	14.5	22.0			
3/4"	6280-034	36.5	15.5	28.0			
1"	6280-100	42.0	18.0	35.0			
1 1/4"	6280-114	47.5	20.5	43.5			
1 1/2"	6280-112	47.5	20.5	49.5			
2"	6280-200	57.0	25.0	62.0			
2 1/2"	6280-212	61.0	27.0	77.5			
3"	6280-300	67.5	30.0	90.5			
4"	6280-400	80.0	36.0	117.0			

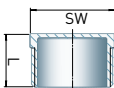

290		HEXAGON PLUGS		MAT. 1.4408			
Size [1 x 2]	Code	Dimensions [mm]					
		L	SW				
1/8"	6290-018	12.0	11.0				
1/4"	6290-014	14.5	15.0				
3/8"	6290-038	16.0	18.0				
1/2"	6290-012	19.5	22.0				
3/4"	6290-034	21.0	28.0				
1"	6290-100	24.0	35.0				
1 1/4"	6290-114	27.0	43.5				
1 1/2"	6290-112	27.0	49.5				
2"	6290-200	32.0	62.0				
2 1/2"	6290-212	34.0	77.5				
3"	6290-300	37.5	90.5				
4"	6290-400	44.0	117.0				

291	SQUARE PLUGS		MAT. 1.4408			
Size [1x2]	Code	Dimensions [mm]				
		L	SW			
1/8"	6291-018	13.0	6.0			
1/4"	6291-014	15.5	7.0			
3/8"	6291-038	16.0	8.0			
1/2"	6291-012	20.5	10.0			
3/4"	6291-034	21.5	12.0			
1"	6291-100	25.0	14.0			
1 1/4"	6291-114	27.5	16.0			
1 1/2"	6291-112	28.5	20.0			
2"	6291-200	33.0	22.0			
2 1/2"	6291-212	37.0	28.0			
3"	6291-300	42.0	32.0			
4"	6291-400	48.0	40.0			

300	HEXAGON CAPS		MAT. 1.4408			
Size [1x2]	Code	Dimensions [mm]				
		L	SW			
1/8"	6300-018	13.5	13.5			
1/4"	6300-014	17.0	17.0			
3/8"	6300-038	17.5	20.5			
1/2"	6300-012	21.0	25.0			
3/4"	6300-034	22.5	31.0			
1"	6300-100	26.0	38.0			
1 1/4"	6300-114	29.0	47.0			
1 1/2"	6300-112	29.0	53.0			
2"	6300-200	33.5	66.0			
2 1/2"	6300-212	38.5	82.0			
3"	6300-300	42.0	95.5			
4"	6300-400	48.5	121.5			

310	HEXAGON BACKNUTS		MAT. 1.4408			
Size [1x2]	Code	Dimensions [mm]				
		L	SW			
1/8"	6310-018	5.0	15.0			
1/4"	6310-014	6.0	18.0			
3/8"	6310-038	6.0	22.0			
1/2"	6310-012	7.0	27.0			
3/4"	6310-034	7.0	32.0			
1"	6310-100	9.0	40.0			
1 1/4"	6310-114	11.0	48.0			
1 1/2"	6310-112	11.0	55.0			
2"	6310-200	13.0	68.0			
2 1/2"	6310-212	15.0	85.0			
3"	6310-300	17.0	100.0			
4"	6310-400	20.0	125.0			

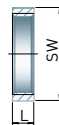
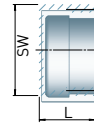
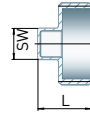

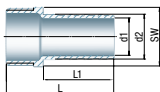

315	HEXAGON HOSE NIPPLES	MAT. 1.4408				
Size [1 x 2]	Code	Dimensions [mm]				
		L	L1	d1	d2	SW
1/8" x 7 mm	6315-1807	33,0	19,0	3,2	6,0	11,0
1/4" x 9 mm	6315-1409	42,5	28,0	5,0	9,0	15,0
3/8" x 11 mm	6315-3811	49,0	33,0	7,0	11,0	18,0
1/2" x 13 mm	6315-1213	59,5	38,0	8,0	13,0	22,0
3/4" x 20 mm	6315-3420	66,0	45,0	15,0	20,0	28,0
1" x 25 mm	6315-1025	75,0	48,0	20,0	25,0	36,0
1 1/4" x 33 mm	6315-11433	79,0	52,0	27,5	33,0	43,5
1 1/2" x 40 mm	6315-11240	83,0	56,0	34,0	40,0	49,5
2" x 52 mm	6315-2052	92,0	60,0	45,0	52,0	62,0
2 1/2" x 63.5 mm	6315-212635	100,0	62,5	56,0	63,5	77,5
3" x 76.5 mm	6315-30765	110,0	70,0	67,0	76,5	90,5
4" x 100 mm	6315-40100	120,0	73,0	90,0	100,0	117,0

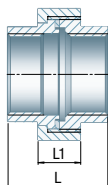

330	UNIONS FLAT SEAT, F/F	MAT. 1.4408			
Size [1 x 2]	Code	Dimensions [mm]			
		L	L1		
1/8"	6330-018	30.0	13.0		
1/4"	6330-014	33.5	13.5		
3/8"	6330-038	36.5	15.0		
1/2"	6330-012	39.5	16.0		
3/4"	6330-034	42.5	17.0		
1"	6330-100	50.0	20.0		
1 1/4"	6330-114	54.0	22.0		
1 1/2"	6330-112	58.0	24.0		
2"	6330-200	65.0	27.0		
2 1/2"	6330-212	75.0	29.5		
3"	6330-300	83.0	31.0		
4"	6330-400	110.0	34.0		

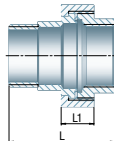

331	UNIONS FLAT SEAT, M/F	MAT. 1.4408			
Size [1 x 2]	Code	Dimensions [mm]			
		L	L1		
1/8"	6331-018	38.0	13.0		
1/4"	6331-014	44.0	13.5		
3/8"	6331-038	47.5	15.0		
1/2"	6331-012	54.0	16.0		
3/4"	6331-034	58.0	17.0		
1"	6331-100	68.0	20.0		
1 1/4"	6331-114	74.5	22.0		
1 1/2"	6331-112	78.5	24.0		
2"	6331-200	90.0	27.0		
2 1/2"	6331-212	102.0	29.5		
3"	6331-300	113.0	31.0		

332		UNIONS FLAT SEAT BOTH ENDS WELDING				MAT. 1.4408	
Size [1x2]	Code	Dimensions [mm]					
		L	L1	D1	d2		
1/4"	6332-014	35.5	13.5	13.5	8.8		
3/8"	6332-038	38.0	15.0	17.2	12.5		
1/2"	6332-012	44.0	16.0	21.3	16.0		
3/4"	6332-034	45.0	17.0	26.9	21.6		
1"	6332-100	50.0	20.0	33.7	27.2		
1 1/4"	6332-114	55.0	22.0	42.4	35.9		
1 1/2"	6332-112	57.0	24.0	48.3	41.8		
2"	6332-200	65.0	27.0	60.3	53.0		
2 1/2"	6332-212	71.0	29.5	76.1	68.8		
3"	6332-300	80.0	31.0	88.9	80.8		

333		UNIONS FLAT SEAT MALE THREAD, WELDING END				MAT. 1.4408	
Size [1x2]	Code	Dimensions [mm]					
		L	L1	D1	d2		
1/4"	6333-014	45.0	13.5	13.5	8.8		
3/8"	6333-038	48.8	15.0	17.2	12.5		
1/2"	6333-012	56.3	16.0	21.3	16.0		
3/4"	6333-034	59.3	17.0	26.9	21.6		
1"	6333-100	69.0	20.0	33.7	27.2		
1 1/4"	6333-114	74.5	22.0	42.4	35.9		
1 1/2"	6333-112	78.0	24.0	48.3	41.8		
2"	6333-200	96.0	27.0	60.3	53.0		
2 1/2"	6333-212	99.3	29.5	76.1	68.8		

334		UNIONS FLAT SEAT FEMALE THREAD, WELDING END				MAT. 1.4408	
Size [1x2]	Code	Dimensions [mm]					
		L	L1	D1	d2		
1/4"	6334-014	34.5	13.5	13.5	8.8		
3/8"	6334-038	37.8	15.0	17.2	12.5		
1/2"	6334-012	41.8	16.0	21.3	16.0		
3/4"	6334-034	43.8	17.0	26.9	21.6		
1"	6334-100	51.0	20.0	33.7	27.2		
1 1/4"	6334-114	54.0	22.0	42.4	35.9		
1 1/2"	6334-112	57.5	24.0	48.3	41.8		
2"	6334-200	71.0	27.0	60.3	53.0		

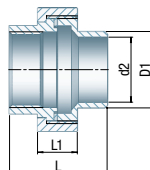
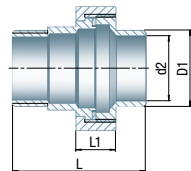
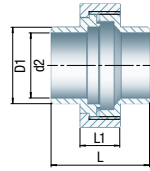

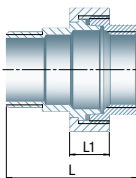
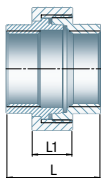
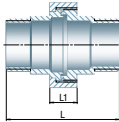

335		UNIONS FLAT SEAT, M/M		MAT. 1.4408			
Size [1 x 2]	Code	Dimensions [mm]					
		L	L1				
1/2"	6335-012	68.5	16.0				
3/4"	6335-034	73.5	17.0				
1"	6335-100	86.0	20.0				
1 1/4"	6335-114	95.0	22.0				
1 1/2"	6335-112	99.0	24.0				

340		UNIONS CONICAL SEAT, F/F		MAT. 1.4408			
Size [1 x 2]	Code	Dimensions [mm]					
		L	L1				
1/8"	6340-018	30.0	13.0				
1/4"	6340-014	33.5	13.5				
3/8"	6340-038	36.5	15.0				
1/2"	6340-012	39.5	16.0				
3/4"	6340-034	42.5	17.0				
1"	6340-100	50.0	20.0				
1 1/4"	6340-114	54.0	22.0				
1 1/2"	6340-112	58.0	24.0				
2"	6340-200	65.0	27.0				
2 1/2"	6340-212	75.0	29.5				
3"	6340-300	83.0	31.0				
4"	6340-400	110.0	34.0				

341		UNIONS CONICAL SEAT, M/F		MAT. 1.4408			
Size [1 x 2]	Code	Dimensions [mm]					
		L	L1				
1/8"	6341-018	38.0	13.0				
1/4"	6341-014	44.0	13.5				
3/8"	6341-038	47.5	15.0				
1/2"	6341-012	54.0	16.0				
3/4"	6341-034	58.0	17.0				
1"	6341-100	68.0	20.0				
1 1/4"	6341-114	74.5	22.0				
1 1/2"	6341-112	78.5	24.0				
2"	6341-200	90.0	27.0				
2 1/2"	6341-212	102.0	29.5				
3"	6341-300	113.0	31.0				

342		UNIONS CONICAL SEAT BOTH ENDS WELDING				MAT. 1.4408	
Size [1x2]	Code	Dimensions [mm]					
		L	L1	D1	d2		
1/4"	6342-014	35.5	13.5	13.5	8.8		
3/8"	6342-038	38.0	15.0	17.2	12.5		
1/2"	6342-012	44.0	16.0	21.3	16.0		
3/4"	6342-034	45.0	17.0	26.9	21.6		
1"	6342-100	50.0	20.0	33.7	27.2		
1 1/4"	6342-114	55.0	22.0	42.4	35.9		
1 1/2"	6342-112	57.0	24.0	48.3	41.8		
2"	6342-200	65.0	27.0	60.3	53.0		
2 1/2"	6342-212	71.0	29.5	76.1	68.8		
3"	6342-300	80.0	31.0	88.9	80.8		

343		UNIONS CONICAL SEAT, MALE THREAD, WELDING END				MAT. 1.4408	
Size [1x2]	Code	Dimensions [mm]					
		L	L1	D1	d2		
1/4"	6343-014	45.0	13.5	13.5	8.8		
3/8"	6343-038	48.8	15.0	17.2	12.5		
1/2"	6343-012	56.3	16.0	21.3	16.0		
3/4"	6343-034	59.3	17.0	26.9	21.6		
1"	6343-100	69.0	20.0	33.7	27.2		
1 1/4"	6343-114	74.5	22.0	42.4	35.9		
1 1/2"	6343-112	78.0	24.0	48.3	41.8		
2"	6343-200	96.0	27.0	60.3	53.0		

344		UNIONS CONICAL SEAT, FEMALE THREAD, WELDING END				MAT. 1.4408	
Size [1x2]	Code	Dimensions [mm]					
		L	L1	D1	d2		
1/4"	6344-014	34.5	13.5	13.5	8.8		
3/8"	6344-038	37.8	15.0	17.2	12.5		
1/2"	6344-012	41.8	16.0	21.3	16.0		
3/4"	6344-034	43.8	17.0	26.9	21.6		
1"	6344-100	51.0	20.0	33.7	27.2		
1 1/4"	6344-114	54.0	22.0	42.4	35.9		
1 1/2"	6344-112	57.5	24.0	48.3	41.8		
2"	6344-200	71.0	27.0	60.3	53.0		

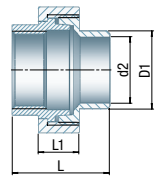
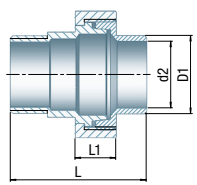
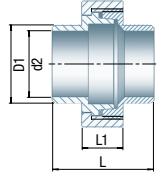

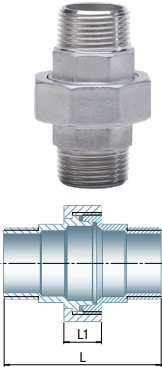

345		UNIONS CONICAL SEAT, M/M		MAT. 1.4408			
Size [1x2]	Code	Dimensions [mm]					
		L	L1				
1/2"	6345-012	68.5	16.0				
3/4"	6345-034	73.5	17.0				
1"	6345-100	86.0	20.0				
2"	6345-200	115.0	27.0				

PTFE seals, different versions on request.

TYP 603

1/4"-2" 1 PC BALL VALVE

- Female thread reduced port and lock handle
- Blow-out proof stem
- Investment casting body
- pressure stages 1000 lbs (69 bar)

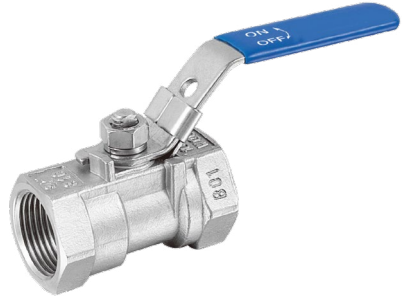
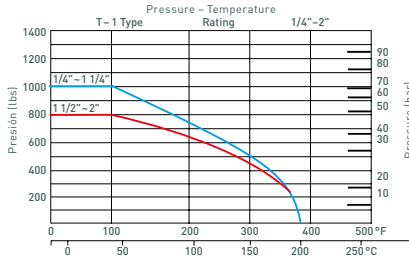

603

1 PC. BALL VALVE. FEMALE THREAD. REDUCED BORE. LOCK HANDLE

MAT. 1.4408

Size	Code	Dimensions [MM]					
		d	L	L1	H	W	S
1/4"	603-014	5.0	39.0	19.0	30.0	70.0	17.0
3/8"	603-038	6.5	44.0	21.0	34.0	90.0	21.0
1/2"	603-012	9.2	56.5	27.5	41.0	100.0	25.0
3/4"	603-034	12.5	59.0	29.0	44.0	100.0	32.0
1"	603-100	15.0	71.0	34.5	50.0	110.0	38.0
1 1/4"	603-114	20.0	78.0	37.0	55.0	110.0	48.0
1 1/2"	603-112	25.0	83.0	40.0	64.0	135.0	53.0
2"	603-200	32.0	100.0	49.0	70.0	145.0	65.0

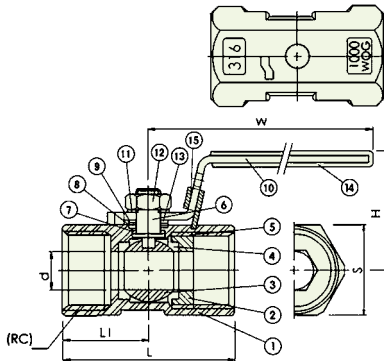

Nº.	Parts	QTY	Material CF8M
1	Body	1	ASTM - A351 - CF8M
2	Insert	1	ASTM - A351 - CF8M
3	Ball	1	ASTM - A351 - CF8M
4	Ball seat	2	PTFE
5	Gasket	1	PTFE
6	Stem	1	AISI 316
7	Trust washer	1	PTFE
8	Stem packing	1	PTFE
9	Stem washer	1	AISI 304
10	Handle	1	AISI 304
11	Spring washer	1	AISI 304
12	Stem nut	1	AISI 304
13	Belleville washer	1	AISI 304
14	Plastic cover	1	PLASTIC
15	Lock device	1	AISI 304

TYP 604

1/4"-3" 2PCS BALL VALVE

- Female thread full port, DIN 3202 M3 and lock handle
- Blow-out proof stem
- Investment casting body
- Pressure stages: 1000 lbs (69 bar)

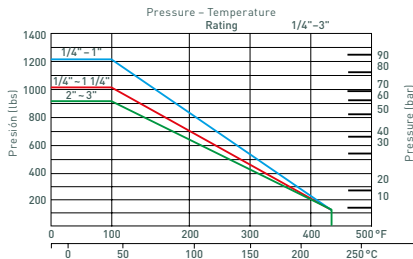

604 2 PCS. BALL VALVE. FEMALE THREAD. FULL BORE. DIN 3202 M3. LOCK HANDLE MAT. 1.4408

Size	Code	Dimensions [mm]					
		d	L	H	W	N	P
1/4"	604-014	11.6	50.0	52.0	102.0	12.7	28.5
3/8"	604-038	12.7	60.0	54.0	102.0	12.7	28.5
1/2"	604-012	15.0	75.0	62.0	123.0	12.7	28.5
3/4"	604-034	20.0	80.0	66.0	123.0	21.0	35.0
1"	604-100	25.0	90.0	77.0	153.0	21.0	35.0
1 1/4"	604-114	32.0	110.0	80.0	153.0	23.5	38.0
1 1/2"	604-112	38.0	120.0	91.0	183.0	23.5	38.0
2"	604-200	50.0	140.0	98.0	183.0	23.5	38.0
2 1/2"	604-212	65.0	185.0	138.0	246.0	35.0	54.0
3"	604-300	80.0	205.0	149.0	246.0	35.0	54.0

Nº.	Parts	Material
1	Body	WCB - CF8M
2	Insert	WCB - CF8M
3	Ball	CF8M
4	Ball seat	PTFE
5	Stem	AISI 316
6	Gasket	PTFE
7	Trust washer	PTFE
8	Stem packing	PTFE
9	Gland	AISI 304
10	Spring washer	AISI 304
11	Stem nut	AISI 304
12	Lock device	AISI 304
13	Handle	AISI 304
14	Plastic cover	PLASTIC

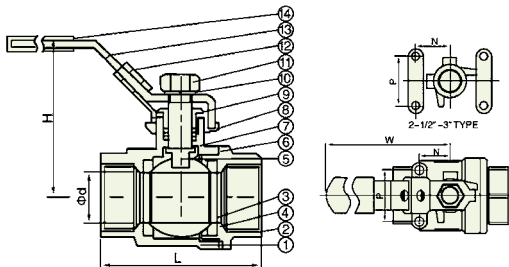

TYP 605

1/4"-4" 2 PCS ECO BALL VALVE

- Female thread full port
- Blow-out proof stem
- Investment casting body
- Pressure stages: 1000 lbs (69 bar)

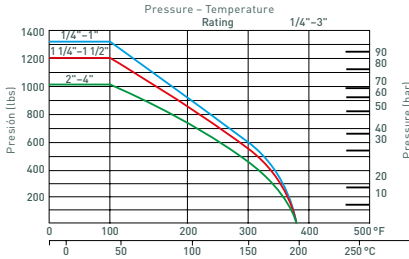

605

2 PCS. ECO BALL VALVE. FEMALE THREAD. FULL BORE

MAT. 1.4408

Size	Code	Dimensions [mm]			
		L	D	H	W
1/4"	605-014	49.0	12.8	51.0	95.0
3/8"	605-038	49.0	12.8	51.0	95.0
1/2"	605-012	57.0	15.0	55.0	95.0
3/4"	605-034	65.0	20.0	59.0	110.0
1"	605-100	78.0	25.0	73.0	135.0
1 1/4"	605-114	90.5	32.0	78.0	135.0
1 1/2"	605-112	105.0	38.0	91.0	147.0
2"	605-200	127.0	50.0	99.0	165.0
2 1/2"	605-212	160.0	65.0	130.0	215.0
3"	605-300	180.0	80.0	142.0	215.0
4"	605-400	220.0	100.0	165.0	310.0

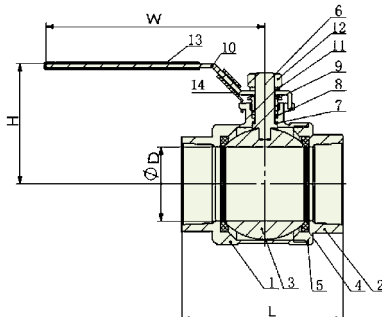

Nº.	Parts	QTY	Material CF8M
1	Body	1	ASTM - A351 - CF8M
2	Insert	1	ASTM - A351 - CF8M
3	Ball	1	ASTM - A351 - CF8M
4	Ball seat	2	PTFE
5	Joint gasket	1	PTFE
6	Stem	1	AISI 316
7	Trust washer	1	PTFE
8	Stem packing	1	PTFE
9	Gland nut	1	AISI 304
10	Handle	1	AISI 304
11	Stem washer	1	AISI 304
12	Stem nut	1	AISI 304
13	Plastic cover	1	PLASTIC
14	Lock device	1	AISI 304

TYP 607

1/4"-4" 3 PCS BALL VALVE

- Welding ends full port, DIN 3202 S5 and lock handle
- Blow-out proof stem
- Investment casting body
- Butt weld end
- Pressure stages: 1000 lbs (69 bar)

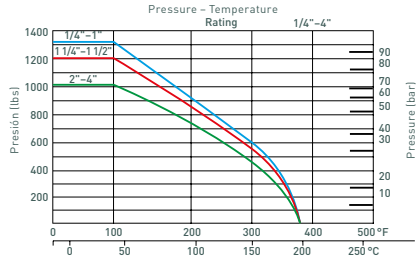

607

3 PCS. BALL VALVE. WELDING ENDS. FULL BORE. DIN 3202 S5. LOCK HANDLE

MAT. 1.4408

Size	Code	Dimensions [mm]					
		d	L	H	W	B	D
1/4" [13.5]	607-014	12.8	59.0	51.0	95.0	12.0	18.0
3/8" [17.2]	607-038	12.8	59.0	51.0	95.0	14.0	18.0
1/2" [21.3]	607-012	15.0	64.0	55.0	95.0	17.1	22.0
3/4" [26.9]	607-034	20.0	75.0	59.0	110.0	22.5	27.5
1" [33.7]	607-100	25.0	85.0	73.0	135.0	28.0	33.5
1 1/4" [42.4]	607-114	32.0	97.0	78.0	135.0	33.5	44.0
1 1/2" [48.3]	607-112	38.0	110.0	91.0	147.0	43.0	50.0
2" [60.3]	607-200	50.0	132.0	99.0	165.0	53.0	61.5
2 1/2" [76.1]	607-212	65.0	167.0	130.0	215.0	65.0	76.0
3" [88.9]	607-300	80.0	187.0	142.0	215.0	80.0	92.0
4" [114.3]	607-400	100.0	230.0	174.0	310.0	100.0	115.0

Nº.	Parts	QTY	Material CF8M
1	Body	1	ASTM - A351 - CF8M
2	Ball	1	ASTM - A351 - CF8M
3	Trust washer	1	PTFE
4	Stem packing	2	PTFE
5	Stem	1	AISI 316
6	Gland nut	1	AISI 304
7	Stem washer	1	AISI 304
8	Stem nut	1	AISI 304
9	Cap	2	ASTM - A351 - CF8M
10	Handle	1	AISI 304
11	Bolt	4-6	AISI 304
12	Hex nut	4-6	AISI 304
13	Spring washer	4-6	AISI 304
14	Ball seat	2	PTFE
15	Joint gasket	2	PTFE
16	Plastic cover	1	PLASTICO
17	Lock device	1	AISI 304

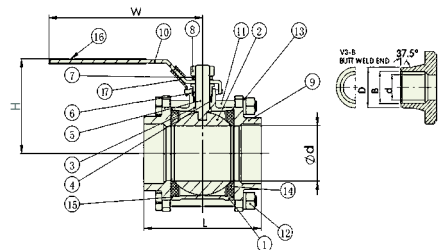

TYP 608

1/4"-4" 3 PCS BALL VALVE

- Female thread full port, DIN 3202 M3 and lock handle
- Blow-out proof stem
- Investment casting body
- Pressure stages: 1000 lbs (69 bar)
- Option: Locking device

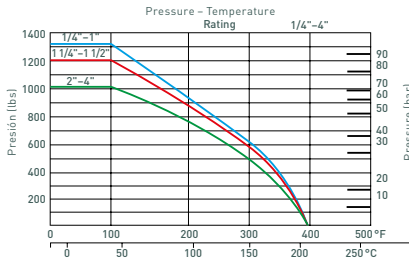

608

3 PCS. BALL VALVE. FEMALE THREAD. FULL BORE. DIN 3202 M3. LOCK HANDLE

MAT. 1.4408

Size	Code	Dimensions [mm]							
		d	L	H	W	ØM	G	Cv Factor	Torque kgf - cm
1/4"	608-014	12.8	59.0	51.0	95.0	36.0	M5	6.6	40.0
3/8"	608-038	12.8	59.0	51.0	95.0	36.0	M5	7.9	40.0
1/2"	608-012	15.0	64.0	55.0	95.0	36.0	M5	11.2	54.0
3/4"	608-034	20.0	75.0	63.0	110.0	36.0	M5	21.0	78.0
1"	608-100	25.0	85.0	74.0	135.0	42.0	M5	35.0	106.0
1 1/4"	608-114	32.0	97.0	80.0	135.0	50.0	M6	57.0	150.0
1 1/2"	608-112	38.0	110.0	92.0	175.0	50.0	M6	80.0	200.0
2"	608-200	50.0	132.0	107.0	180.0	70.0	M8	150.0	280.0
2 1/2"	608-212	65.0	167.0	128.0	250.0	70.0	M8	265.0	500.0
3"	608-300	80.0	187.0	138.0	250.0	70.0	M8	415.0	770.0
4"	608-400	100.0	230.0	180.0	300.0	102.0	M10	780.0	1100.0

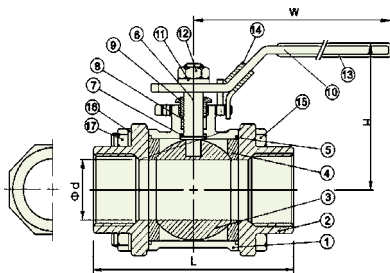

Nº.	Parts	QTY	Material CF8M
1	Body	1	ASTM - A351 - CF8M
2	Cap	2	ASTM - A351 - CF8M
3	Ball	1	ASTM - A351 - CF8M
4	Ball seat	2	PTFE
5	Joint gasket	2	PTFE
6	Stem	1	AISI 316
7	Trust washer	1	PTFE
8	Stem packing	2	PTFE
9	Gland nut	1	AISI 304
10	Handle	1	AISI 304
11	Stem washer	1	AISI 304
12	Stem nut	1	AISI 304
13	Plastic cover	1	PLASTIC
14	Lock device	1	AISI 304
15	Bolt	4 (3", 4" x 6 Pcs.)	AISI 304
16	Spring washer	4 (3", 4" x 6 Pcs.)	AISI 304
17	Hex nut	4 (3", 4" x 6 Pcs.)	AISI 304

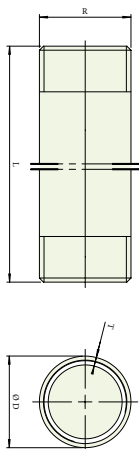

BARREL NIPPLE		MAT. 1.4404
Thread ISO 7/1 (R) x Length(L)	Pipe-outer- \varnothing (D) x Wall thickness (T)	Code
1/8" x 40 mm	10.2 x 2.0 mm	6070.040.01
1/8" x 60 mm	10.2 x 2.0 mm	6070.060.01
1/8" x 100 mm	10.2 x 2.0 mm	6070.100.01
1/4" x 30 mm	13.5 x 2.3 mm	6070.030.02
1/4" x 40 mm	13.5 x 2.3 mm	6070.040.02
1/4" x 60 mm	13.5 x 2.3 mm	6070.060.02
1/4" x 80 mm	13.5 x 2.3 mm	6070.080.02
1/4" x 100 mm	13.5 x 2.3 mm	6070.100.02
1/4" x 120 mm	13.5 x 2.3 mm	6070.120.02
1/4" x 150 mm	13.5 x 2.3 mm	6070.150.02
1/4" x 200 mm	13.5 x 2.3 mm	6070.200.02
3/8" x 40 mm	17.2 x 2.3 mm	6070.040.03
3/8" x 60 mm	17.2 x 2.3 mm	6070.060.03
3/8" x 80 mm	17.2 x 2.3 mm	6070.080.03
3/8" x 100 mm	17.2 x 2.3 mm	6070.100.03
3/8" x 120 mm	17.2 x 2.3 mm	6070.120.03
3/8" x 150 mm	17.2 x 2.3 mm	6070.150.03
3/8" x 200 mm	17.2 x 2.3 mm	6070.200.03
1/2" x 40 mm	21.3 x 2.6 mm	6070.040.04
1/2" x 60 mm	21.3 x 2.6 mm	6070.060.04
1/2" x 80 mm	21.3 x 2.6 mm	6070.080.04
1/2" x 100 mm	21.3 x 2.6 mm	6070.100.04
1/2" x 120 mm	21.3 x 2.6 mm	6070.120.04
1/2" x 150 mm	21.3 x 2.6 mm	6070.150.04
1/2" x 200 mm	21.3 x 2.6 mm	6070.200.04
1/2" x 300 mm	21.3 x 2.6 mm	6070.300.04
3/4" x 40 mm	26.9 x 2.6 mm	6070.040.05
3/4" x 60 mm	26.9 x 2.6 mm	6070.060.05
3/4" x 80 mm	26.9 x 2.6 mm	6070.080.05
3/4" x 100 mm	26.9 x 2.6 mm	6070.100.05
3/4" x 120 mm	26.9 x 2.6 mm	6070.120.05
3/4" x 150 mm	26.9 x 2.6 mm	6070.150.05
3/4" x 200 mm	26.9 x 2.6 mm	6070.200.05
3/4" x 300 mm	26.9 x 2.6 mm	6070.300.05
1" x 40 mm	33.7 x 3.2 mm	6070.040.06
1" x 60 mm	33.7 x 3.2 mm	6070.060.06
1" x 80 mm	33.7 x 3.2 mm	6070.080.06
1" x 100 mm	33.7 x 3.2 mm	6070.100.06
1" x 120 mm	33.7 x 3.2 mm	6070.120.06
1" x 150 mm	33.7 x 3.2 mm	6070.150.06
1" x 200 mm	33.7 x 3.2 mm	6070.200.06
1" x 300 mm	33.7 x 3.2 mm	6070.300.06

BARREL NIPPLE

MAT. 1.4404

Thread ISO 7/1 (R) x Length(L)	Pipe-outer- ϕ (D) x Wall thickness (T)	Code
1 1/4" x 40 mm	42.4 x 3.2 mm	6070.040.07
1 1/4" x 60 mm	42.4 x 3.2 mm	6070.060.07
1 1/4" x 80 mm	42.4 x 3.2 mm	6070.080.07
1 1/4" x 100 mm	42.4 x 3.2 mm	6070.100.07
1 1/4" x 120 mm	42.4 x 3.2 mm	6070.120.07
1 1/4" x 150 mm	42.4 x 3.2 mm	6070.150.07
1 1/4" x 200 mm	42.4 x 3.2 mm	6070.200.07
1 1/2" x 40 mm	48.3 x 3.2 mm	6070.040.08
1 1/2" x 60 mm	48.3 x 3.2 mm	6070.060.08
1 1/2" x 80 mm	48.3 x 3.2 mm	6070.080.08
1 1/2" x 100 mm	48.3 x 3.2 mm	6070.100.08
1 1/2" x 120 mm	48.3 x 3.2 mm	6070.120.08
1 1/2" x 150 mm	48.3 x 3.2 mm	6070.150.08
1 1/2" x 200 mm	48.3 x 3.2 mm	6070.200.08
2" x 40 mm	60.3 x 3.6 mm	6070.040.09
2" x 60 mm	60.3 x 3.6 mm	6070.060.09
2" x 80 mm	60.3 x 3.6 mm	6070.080.09
2" x 100 mm	60.3 x 3.6 mm	6070.100.09
2" x 120 mm	60.3 x 3.6 mm	6070.120.09
2" x 150 mm	60.3 x 3.6 mm	6070.150.09
2" x 200 mm	60.3 x 3.6 mm	6070.200.09
2 1/2" x 100 mm	76.1 x 3.6 mm	6070.100.10
2 1/2" x 120 mm	76.1 x 3.6 mm	6070.120.10
2 1/2" x 150 mm	76.1 x 3.6 mm	6070.150.10
3" x 120 mm	88.9 x 4.0 mm	6070.120.11
3" x 150 mm	88.9 x 4.0 mm	6070.150.11
3" x 200 mm	88.9 x 4.0 mm	6070.200.11
4" x 100 mm	114.3 x 4.5 mm	6070.100.12
4 x 120 mm	114.3 x 4.5 mm	6070.120.12

WELDING NIPPLE

MAT. 1.4404

Thread ISO 7/1 (R) x Length (L)	Pipe-outer- ϕ (D) x Wall thickness (T)	Code
1/8" x 30 mm	10.2 x 2.0 mm	6072.030.01
1/4" x 30 mm	13.5 x 2.3 mm	6072.030.02
3/8" x 30 mm	17.2 x 2.3 mm	6072.030.03
1/2" x 35 mm	21.3 x 2.6 mm	6072.035.04
3/4" x 40 mm	26.9 x 2.6 mm	6072.040.05
1" x 40 mm	33.7 x 3.2 mm	6072.040.06
1 1/4" x 50 mm	42.4 x 3.2 mm	6072.050.07
1 1/2" 50 mm	48.3 x 3.2 mm	6072.050.08
2" x 50 mm	60.3 x 3.6 mm	6072.050.09
2 1/2" x 60 mm	76.1 x 3.6 mm	6072.060.10
3" x 70 mm	88.9 x 4.0 mm	6072.070.11
4 x 80 mm	114.3 x 4.5 mm	6072.080.12

